



(Papers) SSC Junior Engineer Exam Paper - 2018 "held on 27 Jan 2018" Morning Shift (Electrical Engineering)

QID : 301 - Why are same types of cells connected in parallel?

Options:

- 1) To decrease the voltage rating
- 2) To increase the voltage rating
- 3) To decrease the current rating
- 4) To increase the current rating

Correct Answer: To increase the voltage rating

QID : 302 - There are N resistances, each are connected in parallel having value R with equivalent resistance of X. What will be the total resistance when these N resistances are connected in series?

Options:

1)

2)

RNX

3)

$\frac{X}{N}$

4)

$N^2 X$

Correct Answer:

QID : 303 - Which of the following is equivalent to 0.5 kWh?

Options:

- 1) 1800000 W
- 2) 1800000 J
- 3) 18000000 J
- 4) 36000000 J

Correct Answer: 1800000 J

QID : 304 - What is the conductivity (in Mhos/m) of a 2 Ohm circular wire, when the length and the diameter of the wire are 10 m and 0.8 m respectively?

Options:

- 1) 10
- 2) 1
- 3) 0.1
- 4) 5

Correct Answer: 10

QID : 305 - 'Erg' is a unit of measurement for _____.

Options:

- 1) Energy
- 2) Power
- 3) Voltage
- 4) Impedance

Correct Answer: Energy

QID : 306 -

What is the equivalent capacitance (in μF) between the terminals A and B in the circuit given below?

नीचे दिए गए परिपथ में टर्मिनल A और B के बीच समतुल्य संधारिता (μF में) क्या है?

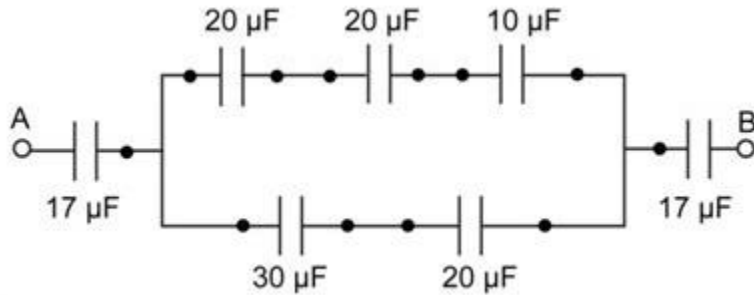

Options:

- 1) 4.56
- 2) 5.67
- 3) 18.58
- 4) 51

Correct Answer: 5.67

QID : 307 -

What is the equivalent inductance (in H) between the terminals A and B in the circuit given below?

नीचे दिए गए परिपथ में टर्मिनल A और B के बीच समतुल्य प्रेरकत्व (हेनरी में) क्या है?

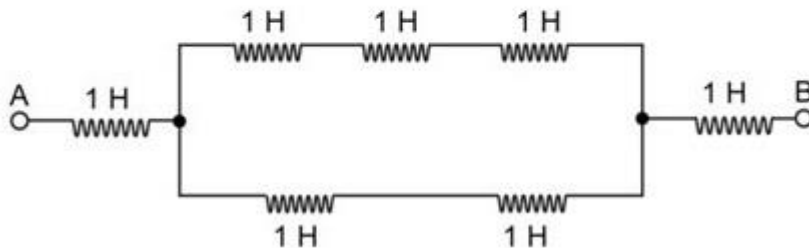

Options:

- 1) 1
- 2) 1.42

3) 3.2

4) 7

Correct Answer: 3.2

QID : 308 - Which of the following quantity will remain the same, when a layer of Teflon is inserted between the plates of a charged parallel plate capacitor?

Options:

1) Capacitance

2) Charge

3) Energy of the capacitor

4) Potential

Correct Answer: Charge

QID : 309 - What will be the value of resistance (in kilo-ohms) of a carbon composition resistor having color-coding of brown-black-brown-black?

Options:

1) 400

2) 200

3) 300

4) 100

Correct Answer: 100

QID : 310 - Which of the following is NOT a type of capacitor?

Options:

1) Ceramic

2) Electrolytic

3) Film

4) Wire wound

Correct Answer: Wire wound

QID : 311 - Which of the following is TRUE in case of Substitution theorem?

Options:

1) The initial condition of the rest of the circuit changes, if a network element is replaced by a voltage source having an equal voltage as the voltage across the element at every

instant of time.

2) The initial condition of the rest of the circuit changes, if a network element is replaced by a voltage source having an equal current as the voltage across the element at every instant of time.

3) The initial condition of the rest of the circuit remains same, if a network element is replaced by a voltage source having an equal voltage as the voltage across the element at every instant of time.

4) The initial condition of the rest of the circuit changes, if a network element is replaced by a voltage source having an equal voltage as the current across the element at every instant of time.

Correct Answer: The initial condition of the rest of the circuit remains same, if a network element is replaced by a voltage source having an equal voltage as the voltage across the element at every instant of time.

QID : 312 - Which of the following theorem states that the sum of instantaneous power in 'n' number of branches of an electrical network is zero?

Options:

1) Compensation

2) Maximum power transfer

3) Superposition

4) Tellegen's

Correct Answer: Tellegen's

QID : 313 - Kirchhoff's voltage law is based on which of the following principle?

Options:

1) Conservation of charge

2) Conservation of energy

3) Conservation of force

4) Conservation of momentum

Correct Answer: Conservation of energy

QID : 314 -

SSC Junior Engineer Exam Printed Study Kit



- 100% Syllabus Covered (Paper-1)
- 3 Books, 500+ Pages
- 2,000+ MCQs
- 5 Practice Tests (PDF Copy)
- 1 Year Current Affairs (PDF Copy)

50%
OFF

~~₹ 3,000/-~~
₹ 1,499/-

FREE
SHIPPING 

[Click Here for More Details](#)

SSCPORTAL.IN

What you will get:

- 100% Syllabus Covered
- 5 Booklets (Paper-1)
- 520+ Pages
- 2,000+ MCQs
- Five Practice Papers
- One Year Current Affairs
- Guidance & Support from Our Experts

Price of the Kit:

~~Rs. 3,000~~

Rs. 1,499/-

(Limited time Offer)

 [Buy Online](#)

Net Banking

[FOR MORE DETAILS CLICK HERE](#)

[Order Online \(100% Safe\)](#)

[Click here for Other Payment Options \(Cash/NEFT/etc\)](#)

50%
OFF

[CLICK HERE](#)

What is the value of an unknown voltage 'V' (in V) across the terminal A and B, in the circuit given below?

नीचे दिए गए परिपथ में टर्मिनल A और B के बीच अज्ञात वोल्टेज (वोल्ट में) क्या है?

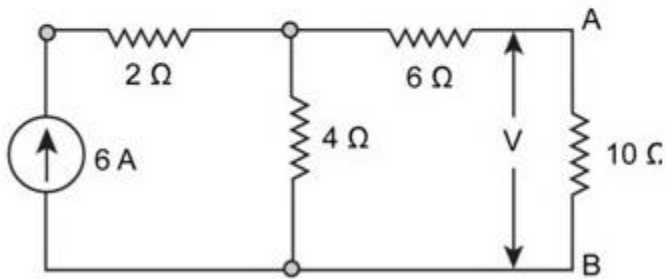

Options:

- 1) 6
- 2) 10
- 3) 12
- 4) 16

Correct Answer: 12

QID : 315 -

What will be the value of source impedance (in Ohms) for transmitting maximum power to the load in the circuit given below?

नीचे दिए गए परिपथ में लोड को अधिकतम शक्ति प्रेषित करने के लिए स्रोत प्रतिबाधा का मान (ओम में) क्या होगा?

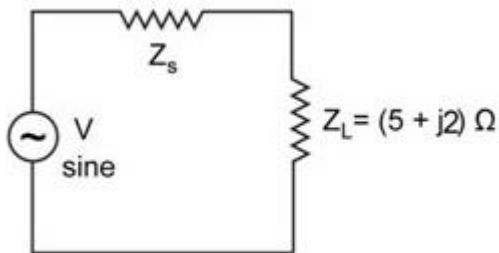

Options:

- 1) $5 + j2$

2) $5 - j 2$

3) $2 + j 5$

4) $2 - j 5$

Correct Answer: $5 - j 2$

QID : 316 -

Determine the value of power dissipated (in W) through the 20Ω resistor of the circuit given below.

नीचे दिए गए परिपथ में 20Ω प्रतिरोधक के माध्यम से अपव्यय शक्ति के मान (वाट में) निर्धारित करें।

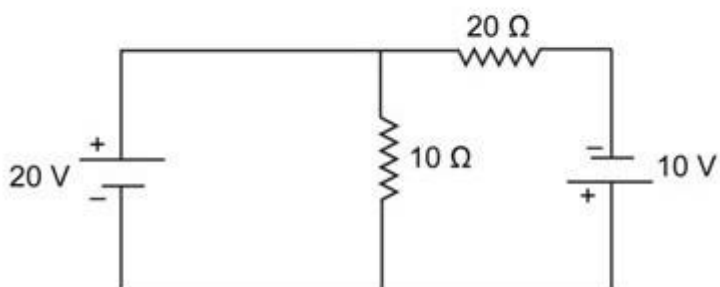

Options:

1) 30

2) 45

3) 60

4) 75

Correct Answer: 45

QID : 317 -

Determine the power dissipated (in W) by the $25\ \Omega$ resistor in the circuit given below.

नीचे दिए गए परिपथ में $25\ \Omega$ प्रतिरोधक के माध्यम से अपव्यय शक्ति के मान (वाट में) निर्धारित करें।

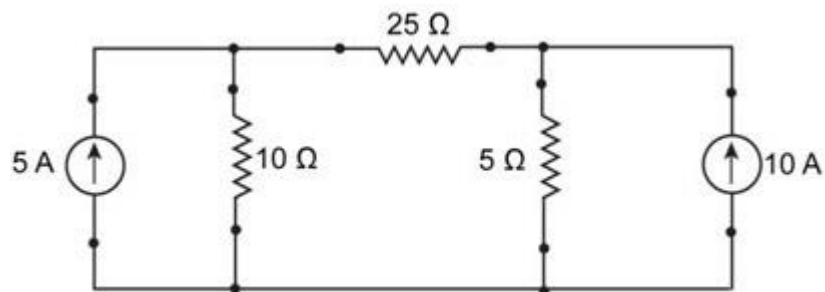

Options:

- 1) 0
- 2) 25
- 3) 125
- 4) 156.25

Correct Answer: 0

QID : 318 -

Determine the total current 'I' (in A) supplied by the voltage source in the circuit given below.

नीचे दिए गए परिपथ में वोल्टेज स्रोत द्वारा प्रदत्त कुल विद्युत् धारा 'I' (एम्पेयर में) निर्धारित करें।

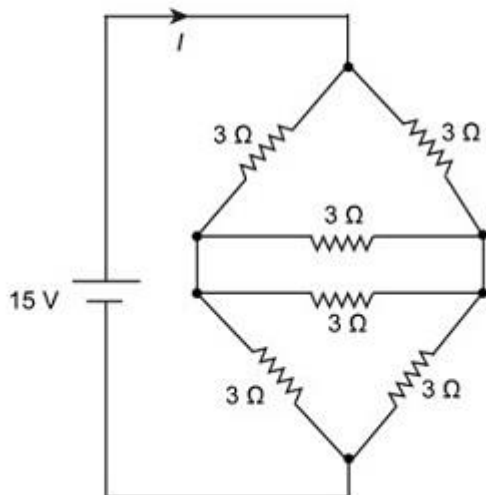

Options:

- 1) 3
- 2) 4
- 3) 5
- 4) 6

Correct Answer: 5

QID : 319 -

Determine the maximum power (in W) transferred from the source to the load of the circuit given below.

नीचे दिए गए परिपथ में स्रोत से लोड तक स्थानांतरित अधिकतम शक्ति (वाट में) निर्धारित करें।

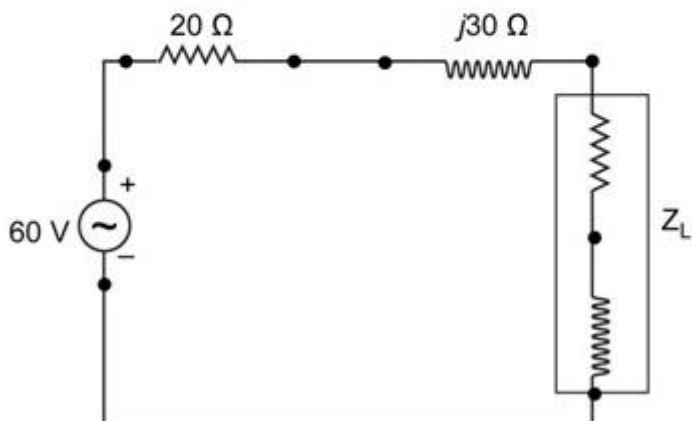

Options:

- 1) 18
- 2) 30
- 3) 45
- 4) 90

Correct Answer: 45

QID : 320 -

Determine the Norton's current (in A) and Norton's resistance (in Ω) respectively, for the given electrical circuit.

दिए गए परिपथ के लिए नॉर्टन विद्युत् धारा (एम्पेयर में) और नॉर्टन प्रतिरोध (Ω में) क्रमशः निर्धारित करें।

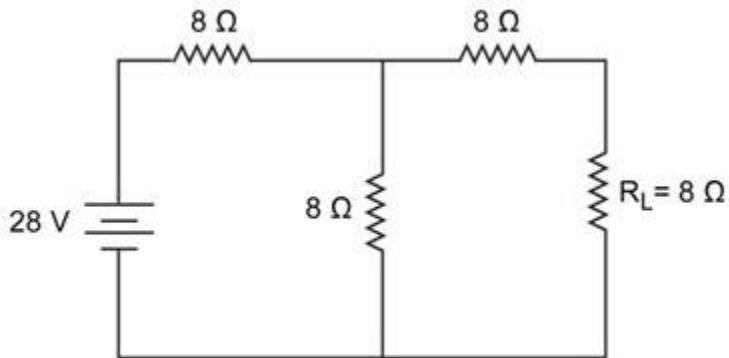

Options:

- 1) 1.167, 12
- 2) 2.345, 14
- 3) 4.434, 16
- 4) 2.346, 10

Correct Answer: 1.167, 12

QID : 321 - The S.I unit of electric charge is _____.

Options:

- 1) Henry
- 2) Coulomb
- 3) Tesla
- 4) Weber

Correct Answer: Coulomb

QID : 322 - Which of the following is a diamagnetic material?

Options:

- 1) Aluminium
- 2) Oxygen
- 3) Lead
- 4) Nickel

Correct Answer: Lead

QID : 323 - Which of the following material shows paramagnetism?

Options:

- 1) Copper
- 2) Iron
- 3) Titanium
- 4) Silver

Correct Answer: Titanium

QID : 324 - Which of the following is the CORRECT expression for Gauss' Law?

Options:

1)

$$\phi_E = \frac{q}{\epsilon_0}$$

2)

$$\phi_E = \frac{\epsilon_0}{q}$$

3)

$$\phi_E = \frac{4E}{H}$$

4)

$$\phi_E = \frac{4H}{E}$$

Correct Answer:

QID : 325 - Determine the intensity of magnetization (in A/m) of a magnet, when its pole strength is 100 Wb and has a pole area of 70 sq. m.

Options:

- 1) 4.98
- 2) 3.65
- 3) 2.53
- 4) 1.43

Correct Answer: 1.43

QID : 326 - Hysteresis loss occurring in a material does NOT depend on which of the following parameters?

Options:

- 1) Hysteresis constant
- 2) Magnetic flux density
- 3) Frequency
- 4) Reluctivity

Correct Answer: Reluctivity

QID : 327 - Determine the eddy current loss (in W) in a material having eddy current coefficient of 1, thickness of 0.02 m and a volume of 1 cubic metre, which is kept in a magnetic field of maximum flux density of 2 T and supplied by a frequency of 50 Hz.

Options:

- 1) 2
- 2) 3
- 3) 4
- 4) 5

Correct Answer: 4

QID : 328 - What will be the self-inductance (in mH) of a 4 m long air-core solenoid, if the diameter of the solenoid is 50 cm and has 300 turns?

Options:

- 1) 5.54
- 2) 6.94
- 3) 7.85
- 4) 8.64

Correct Answer: 5.54

QID : 329 - What is the coupling factor between the two coils, each having self inductance of 25 mH and the mutual inductance between the two is 25 mH?

Options:

- 1) 0.5
- 2) 0.75
- 3) 1

4) 2

Correct Answer: 1

QID : 330 - Determine the magnitude of the EMF (in V) induced between the axis of rotation and the rim of the disc, when the disc of radius 10 cm rotates with an angular velocity of 10 revolutions per second, which is placed in a magnetic field of 4 T acting parallel to the rotation of the disc.

Options:

1) 0.5

2) 0.75

3) 1

4) 1.25

Correct Answer: 1.25

QID : 331 - Determine the peak value (in A) of the current used by a motor rated at 220 V, 30 A.

Options:

1) 21.2

2) 30

3) 42.4

4) 51.9

Correct Answer: 42.4

QID : 332 - What will be the frequency (in Hz) of a sinusoidal wave, when the time period is 20 ms?

Options:

1) 50

2) 60

3) 40

4) 30

Correct Answer: 50

QID : 333 -

Study Kit for SSC Stenographers (Grade 'C' & 'D') Examination (Paper - 1)



- Medium: English
- 100% Syllabus Covered
- 3000 + MCQs
- 700+ Pages

**SPECIAL
OFFER**

Only
~~MRP ₹ 3000/-~~
Offer ₹ 1499/-

[Click Here for More Details](#)

What you will get:

- 100% Syllabus Covered
- 6 Booklets
- 700+ Pages
- 3000+ MCQs
- Five Practice Papers
- One Year Current Affairs
- Guidance & Support from Our Experts

Price of the Kit:

~~Rs. 3,000~~

Rs. 1,499/-
(Limited time Offer)



Net Banking

[FOR MORE DETAILS CLICK HERE](#)

[Order Online \(100% Safe\)](#)

[Click here for Other Payment Options \(Cash/NEFT/etc\)](#)

**50%
OFF**

Determine the instantaneous value of the alternating current (in A), which is represented by $i(t) = 10 \sin(25t - 15) A$, if the value of t is 3?

प्रत्यावर्ती विद्युत् धारा का तात्कालिक मान (एम्पेयर में) निर्धारित करें, जिसे $i(t) = 10 \sin(25t - 15) A$ द्वारा दर्शाया जाता है, यदि t का मान 3 है?

Options:

- 1) 9.36
- 2) 7.87
- 3) 8.66
- 4) 4.42

Correct Answer: 8.66

QID : 334 - At resonant frequency, the impedance of a series resonant circuit is _____.

Options:

- 1) zero
- 2) maximum
- 3) infinite
- 4) minimum

Correct Answer: minimum

QID : 335 - Determine the value of the phase angle (in degrees) in a series RC circuit having a resistance of 20 ohms and capacitive reactance of 11.56 ohms when supplied by a frequency of 50 Hz.

Options:

- 1) 60
- 2) 30
- 3) 90
- 4) 45

Correct Answer: 30

QID : 336 - A 3-phase delta connected system is supplied by a line voltage of 200 V. The value of phase current is 30 A. What is the total power consumed (in W) by the system, if the current lags the voltage by 30 degrees?

Options:

- 1) 16.32
- 2) 14.45
- 3) 15.59
- 4) 16.69

Correct Answer: 15.59

QID : 337 -

What will be the capacitive susceptance (in Siemens) of the circuit given below?

नीचे दिए गए परिपथ में संधारिता की ससेप्टेंस (सीमेंस में) क्या होगी?

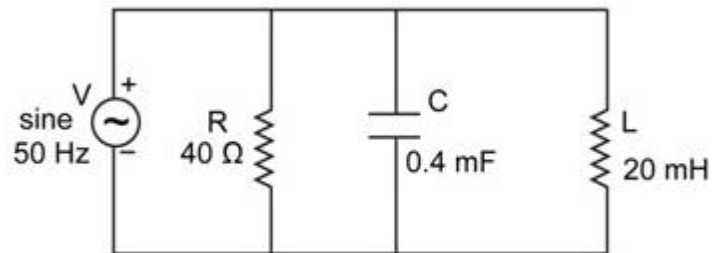

Options:

- 1) 0.126
- 2) 1.26
- 3) 12.6
- 4) 126.1

Correct Answer: 0.126

QID : 338 - Determine the reactive power (in kVAR) of a 3-phase delta connected system having a line voltage of 400 V, line current of 40 A and the phase difference between the voltage and current is 45 degrees.

Options:

- 1) 14.4

2) 15.8

3) 18.7

4) 19.6

Correct Answer: 19.6

QID : 339 - Determine the quality factor of a series RLC circuit, when the value of capacitance is 0.02 mF, the value of inductance is 8 mH and the value of resistance is 40 ohms.

Options:

1) 0.5

2) 0.4

3) 0.8

4) 1.3

Correct Answer: 0.5

QID : 340 - What will be the time (in seconds) taken by the inductor reach its maximum steady state value in a series RL circuit, when the value of the inductance is 0.8 H and the value of the resistance is 10 Ohms?

Options:

1) 0.2

2) 0.6

3) 0.4

4) 0.8

Correct Answer: 0.4

QID : 341 - Which one of the following is the dimension of energy?

Options:

1)

$$\frac{ML^2}{T^3}$$

2)

$$\frac{ML^2}{T^2}$$

3)

$$\frac{T^2}{ML^2}$$

4)

$$\frac{ML^2}{QT^2}$$

Correct Answer:

QID : 342 - Which one of the following statement is NOT TRUE about the MI type instruments?

Options:

- 1) MI type Instruments are suitable for both AC and DC circuits.
- 2) Frictional error in MI type instruments is very less.
- 3) The torque weight ratio of MI type instruments is high.
- 4) The instrument cost is much higher as compared to PMMC type instruments.

Correct Answer: The instrument cost is much higher as compared to PMMC type instruments.

QID : 343 - Which one of the following statement is NOT TRUE about multimeter?

Options:

- 1) Multimeter can be used for the measurement of voltage.
- 2) Multimeter can be used for the measurement of power.
- 3) Multimeter can be used for the measurement of resistance.
- 4) Multimeter can be used for the measurement of current.

Correct Answer: Multimeter can be used for the measurement of power.

QID : 344 - Which one of the following is the main cause of magnetic decay in PMMC type instrument?

Options:

- 1) Variation in the resistance of the moving coil
- 2) Quality of spring
- 3) Aging of the spring
- 4) Aging of the magnets

Correct Answer: Aging of the magnets

QID : 345 -

Determine the quality factor in Hay's bridge given below, if the bridge is supplied by a frequency of 50 Hz.

यदि ब्रिज को 50 हर्ट्ज की आवृत्ति से आपूर्ति दी जाती है तो नीचे दिए गए हेस ब्रिज में गुणवत्ता कारक निर्धारित करें।

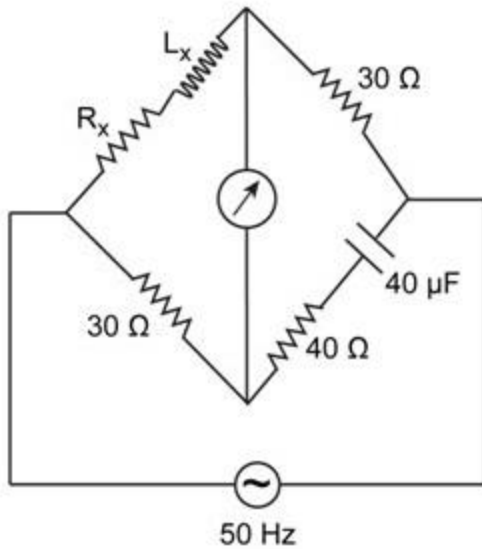

Options:

- 1) 2
- 2) 1
- 3) 0
- 4) 4

Correct Answer: 2

QID : 346 - Determine the apparent power (in W) of a circuit, if the circuit have a power factor of 0.8 and the reactive power of the circuit is 60 W.

Options:

- 1) 80
- 2) 75
- 3) 60
- 4) 55

Correct Answer: 75

QID : 347 - A building has 3 floors and each floor has 4 fans of 50 W that operates for 12 hours a day and one air conditioner of 3000 W that operates for 2 hours per day in the month of the June. Determine the energy consumption (in kWh) of the building in June.

Options:

- 1) 512
- 2) 252
- 3) 756
- 4) 504

Correct Answer: 756

QID : 348 - Determine the reading (in kW) of both the wattmeters used to measure the power of a three-phase three-wire system having input of 6 kW and power factor of 1.

Options:

- 1) 4, 2
- 2) 5, 1
- 3) 3, 3
- 4) 6, 0

Correct Answer: 3, 3

QID : 349 - What will be the secondary voltage (in V) of a potential transformer, if the value of system voltage is 11,000 V, the turn's ratio of the potential transformer is 108 and the percentage voltage error of the transformer is 5%?

Options:

- 1) 86.8
- 2) 93.6
- 3) 84.6
- 4) 96.8

Correct Answer: 96.8

QID : 350 - Determine the full-scale reading (in V) of a PMMC type voltmeter, when the internal resistance of the voltmeter is 230 kilo-ohms, the series resistance connected with the voltmeter is 70 kilo-ohms and the sensitivity of the voltmeter is 3 kilo-ohms/volt.

Options:

- 1) 200

2) 150

3) 100

4) 250

Correct Answer: 100

QID : 351 - The brush contact losses in a d.c. machine is

Options:

1) Inversely proportional to the square of current

2) Directly proportional to the square of current

3) Inversely proportional to the current

4) Directly proportional to the current

Correct Answer: Directly proportional to the current

QID : 352 - In which transformer, the tertiary winding is used

Options:

1) Star - delta

2) Star - star

3) Delta - delta

4) Delta - star

Correct Answer: Star - star

QID : 353 - Secondary winding of an auto transformer is also called_____.

Options:

1) compensating winding

2) common winding

3) tertiary winding

4) damping winding

Correct Answer: common winding

QID : 354 - The maximum allowable voltage between adjacent segment is

Options:

1) 10-20V

2) 20-30V

3) 40-50V

4) 30-40V

Correct Answer: 30-40V

QID : 355 - The field control of a DC shunt motor gives_____.

Options:

- 1) constant torque drive
- 2) constant kW drive
- 3) constant speed drive
- 4) variable load speed drive

Correct Answer: constant kW drive

QID : 356 - The no load current in a transformer is

Options:

- 1) Sinusoidal
- 2) nonSinusoidal
- 3) Trapezoidal
- 4) stepped

Correct Answer: nonSinusoidal

QID : 357 - Transformer cooling and insulation oil must be of

Options:

- 1) low viscosity
- 2) high viscosity
- 3) low BDV
- 4) low resistivity

Correct Answer: low viscosity

QID : 358 - Single Phase transformers can be used in parallel only when their voltages are

Options:

- 1) Equal
- 2) Unequal
- 3) Zero
- 4) None of these

Correct Answer: Equal

QID : 359 - When the phase sequence of supply currents are reversed, then the direction of rotation of the resultant magnetic field wave

Options:

- 1) not unchanged
- 2) to and fro
- 3) reversed
- 4) None of these

Correct Answer: reversed

QID : 360 - The availability of full -rated torque at starting is obtained from induction motor is

Options:

- 1) rotor resistance control
- 2) stator voltage control
- 3) slip ring control
- 4) line current control

Correct Answer: rotor resistance control

QID : 361 - The starting torque of a 1-phase induction motor is

Options:

- 1) High
- 2) Moderate
- 3) Low
- 4) Zero

Correct Answer: Zero

QID : 362 - In a shaded pole single-phase motor, the revolving field is produced by the use of

Options:

- 1) inductor
- 2) capacitor
- 3) resistor
- 4) shading coils

Correct Answer: shading coils

QID : 363 - The repulsion-start induction-run motor is used because of_____.

Options:

- 1) good power factor
- 2) high efficiency
- 3) minimum cost
- 4) high starting torque

Correct Answer: high starting torque

QID : 364 - The rotor slots, in an induction motor, are usually not quite parallel to the shaft because it

Options:

- 1) improves the efficiency
- 2) helps the rotor teeth to remain under the stator teeth
- 3) helps in reducing the tendency of the rotor teeth to remain under the stator teeth
- 4) improves the power factor

Correct Answer: helps in reducing the tendency of the rotor teeth to remain under the stator teeth

QID : 365 - A shaded pole motor can be used for

Options:

- 1) toys
- 2) hair dryers
- 3) circulators
- 4) any of the options

Correct Answer: any of the options

QID : 366 - The rotor of a hysteresis motor is made of

Options:

- 1) aluminium
- 2) cast iron
- 3) chrome steel
- 4) copper

Correct Answer: chrome steel

QID : 367 - The main advantage of AC transmission system over DC transmission system is

Options:

- 1) easy transformation
- 2) less losses in transmission over long distances
- 3) less insulation problems
- 4) less problem of instability

Correct Answer: less losses in transmission over long distances

QID : 368 - Next lower voltage line feeding areas on either side of the main transmission line is called

Options:

- 1) secondary distribution
- 2) secondary transmission
- 3) primary transmission
- 4) primary distribution

Correct Answer: secondary transmission

QID : 369 - ACSR stands for

Options:

- 1) All Copper Standard Reinforced Conductor
- 2) Aluminium Conductor Steel Reinforced Conductor
- 3) Aluminium Copper Steel Reinforced Conductor
- 4) All Copper Steel Reinforced Conductor

Correct Answer: Aluminium Conductor Steel Reinforced Conductor

QID : 370 - The insulating material for cables should have

Options:

- 1) high dielectric strength
- 2) high mechanical strength
- 3) low cost
- 4) all options are correct

Correct Answer: all options are correct

QID : 371 - The main source of hydro-electric power station is

Options:

- 1) coal
- 2) generator

- 3) water
- 4) nuclear

Correct Answer: water

QID : 372 - The function of circuit breaker is

Options:

- 1) to safe guard the circuit
- 2) to On and Off the circuit
- 3) to safe human life
- 4) None of these

Correct Answer: to safe guard the circuit

QID : 373 - Wiring clips are usually made of

Options:

- 1) copper
- 2) steel
- 3) Brass
- 4) aluminium

Correct Answer: steel

QID : 374 - The switch unit need not be on the what type of wire

Options:

- 1) Phase
- 2) Neutral
- 3) earth
- 4) any of the options

Correct Answer: Neutral

QID : 375 - One unit of electrical energy equals

Options:

- 1) 1Kwh
- 2) 1Wh
- 3) 10 Wh

4) 100 Wh

Correct Answer: 1Kwh

QID : 376 - Filaments of electric bulbs are usually made of

Options:

- 1) Nichrome
- 2) carbon
- 3) copper
- 4) tungsten

Correct Answer: tungsten

QID : 377 - Insulation resistance is expressed by

Options:

- 1) ohm
- 2) milli ohm
- 3) mega ohm
- 4) micro ohm

Correct Answer: mega ohm

QID : 378 - In which of the following equipments, current rating is not necessary?

Options:

- 1) circuit breaker
- 2) relay
- 3) Isolator
- 4) load break switch

Correct Answer: Isolator

QID : 379 - which type of fan used between dust collector and chimney in thermal power plant

Options:

- 1) Forced draft
- 2) Induced draft
- 3) Ceiling fan
- 4) Table fan

Correct Answer: Induced draft

QID : 380 - Who invented the electric bulb?

Options:

- 1) Tesla
- 2) Marconi
- 3) Edison
- 4) Benjamin

Correct Answer: Edison

QID : 381 - Incandescent lamp is filled by

Options:

- 1) argon gas
- 2) oxygen gas
- 3) carbon di oxide
- 4) Sulphur oxide

Correct Answer: argon gas

QID : 382 - In house wiring which type of insulation is used?

Options:

- 1) rubber
- 2) P.V.C
- 3) V.I.R
- 4) Paper

Correct Answer: rubber

QID : 383 - The unit of solid angle is

Options:

- 1) Solid angle
- 2) Radian
- 3) Steradian
- 4) Candela

Correct Answer: Steradian

QID : 384 - In case of frosted GLS lamps, frosting of shell is done by_____.

Options:

- 1) Acid etching
- 2) ammonia

- 3) ozone
- 4) salt water

Correct Answer: Acid etching

QID : 385 - The resistance of arc

Options:

- 1) Decreases with increase of the current
- 2) Increases with increase of the current
- 3) Does not depend on current
- 4) None of these

Correct Answer: Decreases with increase of the current

QID : 386 - For welding duty the rectifier commonly used are

Options:

- 1) Mercury arc rectifier
- 2) Selenium metal rectifier
- 3) Both Mercury arc rectifier and Selenium metal rectifier
- 4) None of these

Correct Answer: Selenium metal rectifier

QID : 387 - The device necessarily used for automatic temperature control in a furnace is

Options:

- 1) Thermostat
- 2) Auto-transformer
- 3) Thermo-couple
- 4) Any of the options

Correct Answer: Thermo-couple

QID : 388 - The ideal method of heating plastics is

Options:

- 1) Coal/oil fired furnace
- 2) Dielectric heating
- 3) Induction heating
- 4) Resistance heating

Correct Answer: Dielectric heating

QID : 389 - Which of the following element belongs to the same group of periodic tables as that of silicon and lead?

Options:

- 1) Phosphorous
- 2) Carbon
- 3) Arsenic
- 4) Mercury

Correct Answer: Arsenic

QID : 390 - The merging of a free electron and a hole is known as

Options:

- 1) recombination
- 2) extrusion
- 3) absorption
- 4) adsorption

Correct Answer: recombination

QID : 391 - The circuit that would be used for 455 kHz, if amplifier is

Options:

- 1) resistance loaded
- 2) double tuned transformer
- 3) video amplifier
- 4) class C

Correct Answer: double tuned transformer

QID : 392 - A transistor is a combination of two p-n junction with their

Options:

- 1) p region connected together
- 2) n region connected together
- 3) n region connected to other p region
- 4) p region connected together and n region connected together

Correct Answer: p region connected together and n region connected together

QID : 393 - What are the ON/OFF terminals of a transistor when it is operated as a switch?

Options:

- 1) Collector to base
- 2) Collector to emitter
- 3) Base to collector
- 4) Emitter to base

Correct Answer: Collector to emitter

QID : 394 - If negative feedback is used in the amplifier circuit, it_____.

Options:

- 1) increases distortion
- 2) increases gain
- 3) reduces distortion
- 4) no effect on distortion

Correct Answer: reduces distortion

QID : 395 - The power factor of a synchronous motor ,When the field is under-excited

Options:

- 1) leading
- 2) unity
- 3) lagging
- 4) zero

Correct Answer: lagging

QID : 396 - To limit the operating temperature of synchronous motor, it should have proper

Options:

- 1) current rating
- 2) voltage rating
- 3) power factor
- 4) speed

Correct Answer: current rating

QID : 397 - A synchronous machine with large air gap has_____.

Options:

- 1) a higher value of stability limit
- 2) a higher synchronizing power
- 3) a small value of regulation
- 4) all options are correct

Correct Answer: all options are correct

QID : 398 - synchronous motors speed

Options:

- 1) decreases as the load decreases
- 2) increases as the load increases
- 3) always remains constant
- 4) None of these

Correct Answer: always remains constant

QID : 399 - The magnitude of field flux in a 3-phase synchronous machine

Options:

- 1) varies with speed
- 2) remains constant at all loads
- 3) varies with power factor
- 4) varies with the load

Correct Answer: remains constant at all loads

QID : 400 - In a synchronous motor, the magnitude of back e.m.f depends on_____.

Options:

- 1) speed of the motor
- 2) d.c. excitation only
- 3) load on the motor
- 4) both the speed and rotor flux

Correct Answer: d.c. excitation only



SSC EXAMS PRINTED STUDY NOTES

Study Material for SSC CGL (Tier-1) Examination	English	CLICK HERE
Study Kit for SSC CGL (Tier-2) Exam	English	CLICK HERE
Study Kit for SSC CHSL (10+2) Examination	English	CLICK HERE
Study Kit for SSC Stenographers (Grade 'C' & 'D')	English	CLICK HERE
Study Kit for Multitasking (Non-Technical) - MTS	English	CLICK HERE
Study Kit for SSC Constables (GD) Exam	English	CLICK HERE
Study Kit For SSC Sub-Inspectors in Delhi Police, CAPFs, CISF	English	CLICK HERE
Study Kit for SSC Junior Engineer Exam (Paper-1)	English	CLICK HERE
IAS EXAMS STUDY MATERIALS		
Study Kit for IAS (Pre) GENERAL STUDIES Paper-1 (GS)	English	CLICK HERE
Study Kit for IAS (Pre) CSAT Paper-2(Aptitude)	English	CLICK HERE
सामान्य अध्ययन (GS) प्रारंभिक परीक्षा (Pre) पेपर-1	हिन्दी	CLICK HERE
आई. ए. एस. (सी-सैट) प्रारंभिक परीक्षा पेपर -2	हिन्दी	CLICK HERE
Gist of NCERT Study Kit For UPSC Exams	English	CLICK HERE
यूपीएससी परीक्षा के लिए एनसीईआरटी अध्ययन सामग्री	हिन्दी	CLICK HERE